

USER MANUAL

D3024 & D3024R
High Speed (Refrigerated) Micro-Centrifuge



SCIOLOGEX, LLC

www.scilogex.com



Before using centrifuge, please carefully read this user manual for efficient operation and safety.

Contents

Copyright	3
Safety Reminder	4
1. Specifications	6
2. Declaration of Conformity	6
3. Required Operation Conditions	7
3.1 Basic Operation Conditions	7
3.2 Transport and Storage Conditions.....	7
4. Installation	7
4.1 Location	7
4.2 Connection of the Power Cord and Grounding.....	7
5. Structure	8
6. Operation Panel	10
7. Rotor Preparation	12
7.1 Prepare the Samples	12
7.2 Inject the Samples into the Tubes	12
7.3 Keep the Tubes Balanced	12
7.4 Inspect the Rotor	12
7.5 Symmetrically Load Centrifuge Tubes to Rotor	12
8. Operation	13
8.1 Normal Operation	13
8.2 RCF Operation	16
8.3 Pulse Operation	16
9. Maintenance	17
9.1 Cleaning	17
9.2 Consumables	18
9.3 The Replacement of Seal Rings	18
9.4 Routine Inspection	18
10. Troubleshooting	19
10.1 Possible Problems and Solutions	19
10.2 How to Open the Door	19
10.3 Replacement of Fuses	20
11. Instructions for the Rotor and Tubes	20
11.1 Rotor Instructions	20
11.2 Tubes	22
12. Calculate RCF	23
13. Ordering Information	24
14. Warranty	25
14.1 Warranty of the Centrifuge	25
14.2 Warranty of the Rotor	25
15. After-sales Service	25

Copyright:

No part of this manual may be reproduced or transmitted without prior written permission of SCILOGEX.

We can not be responsible to inform at real-time if the outline and specifications of centrifuge are subject to change for improvement.

VERSION201104

Safety Reminder

Common safety precautions

Carefully read the following safety precautions for a thorough understanding.

- Follow the instructions and procedures described in this manual to operate this centrifuge safely.
- Carefully read all safety messages in this manual and the safety instructions on the centrifuge.
- Safety messages are labeled as indicated below. They are in combination with signal words of “WARNING” and “CAUTION” with the safety alert symbol to call your attention to items or operations that could be dangerous to you or other persons using this centrifuge. The definitions of signal words are as follows:

 **WARNING:Personal Danger**

Warning notes indicate any condition or practice, which if not strictly observed, could result in personal injury or possible death.

 **CAUTION:Possible damage to centrifuge**

Caution notes indicate any condition or practice, which if not strictly observed or remedied, could result in damage or destruction of the centrifuge.

NOTE:Notes indicate an area or subject of special merit, emphasizing either the product’ s capability or common errors in operation or maintenance.

- Do not operate this centrifuge in any manner not described in this User manual. When in doubt or have any troubles with this centrifuge, ASK FOR HELP.
- The precautions described in this User manual are carefully developed in an attempt to cover all the possible risks. However, it is also important that you are alert for unexpected incidents. Be careful operating this centrifuge.

 **WARNING**

- This centrifuge is not explosion-proof. Never use explosive or flammable samples.
 - Do not install the centrifuge in or near places where inflammable gases are generated or chemicals are stored.
 - Do not place dangerous materials within 30cm around the centrifuge.
 - Prepare all necessary safety measures before using samples that are toxic, radioactive or contaminated with pathogenic micro-organisms. Use of these is at your own responsibility.
 - If the centrifuge, rotor and accessories that have been contaminated by solutions with toxic, radioactive or pathogenic materials, clean it according to the decontamination procedure as specified.
 - If you require service at site, please sterilize and decontaminate the centrifuge in advance, and then notify the service center the details of the materials and procedure.
 - To avoid electrical shocks, insure hands are dry before handling the power cord or turn on/off the power switch.
 - For safety purposes, do not enter within 30cm around this centrifuge when it is in operation.
 - While the rotor is rotating, never release the door lock.
- Unauthorized repairs, disassembly or modifying the centrifuge except by our service center are strictly prohibited.

 **CAUTION**

- This centrifuge must be located on a firm and level table.
- Make sure the centrifuge is horizontal before running.
- Make sure the angle between the door and cover is greater than 70 degrees when opening the door.
- Be careful not put your fingers or hands between the door and cover while the door is open.
- Do not move or relocate the centrifuge when it is running.
- If fluid spills in the rotor chamber, please promptly clean and dry with a dry cloth to avoid sample contamination.
- Ensure to remove any objects and fragments of the tubes dropped inside the rotor chamber before running the centrifuge.
- Cautions with rotor
 - (1) Always check for corrosion and damages on the rotor surface before using it. Do not use the rotor if an abnormality is found.
 - (2) Do not set the speed beyond the allowable minimum speed of the rotor kits (rotor or adapters). Make sure to run it below the allowable minimum speed.
 - (3) Do not exceed the allowable imbalance.
 - (4) Use the rotor and tubes within their actual capacities.
 - (5) If the rotor is attached with a lid, ensure it is tightened before operation.
- If any abnormal condition occurs during operation, please stop it immediately and contact our service center. Notify the service center is a warning code if displayed.
- Vibrations are likely to damage the centrifuge, contact our service center if abnormality observed.

1. Specifications

Maximum speed	15000rpm(200-15000rpm), increment: 10rpm
Maximum RCF	21380×g, increment: 10×g
Maximum capacity	2ml×24, 0.5ml×36, 4-PCR8 serial tubes
Temperature range	-20℃~40℃(D3024R)
Timer	30seconds -99minutes-HOLD, continuous operation
Driving Motor	Brushless DC motor
Safety devices	Dual door interlock; Over-speed detector; Over-temperature detector; Automatic internal diagnosis
Power requirements	D3024: Single-phase, 220V-240V, 50Hz/60Hz, 5A. 110V-120V, 50Hz/60Hz, 5A
	D3024R: Single-phase, 220V-240V, 50Hz/60Hz, 10A. 110V-120V, 50Hz/60Hz, 10A
Dimensions(mm)	D3024:(L)280×(W)364×(H)266
	D3024R:(L)338×(W)580×(H)324
Weight	D3024: 12kg D3024R: 30kg
Additional features	Speed/RCF switch; Pulse operation; Processing display; Voice reminder

2. Declaration of Conformity

Construction in accordance with the following safety standards:
EN 61010-1
EN 61010-2-20
Construction in accordance with the following EMC standards:
EN 61326-1/ FCC Part 15 Subpart B/ IECS 001
Associated EU guidelines:
EMC-guidelines: 2004/108/EC
Centrifuge guidelines: 2006/95/EC
This ISM device complies with Canadian ICES-001.
Cet appareil ISM est conforme à la norme NMB-001 du Canada.

Changes or modifications not expressly approved by the party responsible for compliance could void the user's authority to operate the equipment.

NOTE: This centrifuge has been tested and found to comply with the limits for a Class A digital device, pursuant to Part 15 of the FCC Rules. These limits are designed to provide reasonable protection against harmful interference when the centrifuge is operated in a commercial environment. The centrifuge generates, uses, and can radiate radio frequency energy and, if not installed and used in accordance with the user manual, may cause harmful interference to radio communications. Operation of centrifuge in a residential area is likely to cause harmful interference in which case the user will be required to correct the interference.

3. Required Operation Conditions

3.1 Basic operation conditions

(1) Power:

D3024: Single-phase, 220V-240V, 50Hz/60Hz, 5A; 110V-120V, 50Hz/60Hz, 5A

D3024R: Single-phase, 220V-240V, 50Hz/60Hz, 10A; 110V-120V, 50Hz/60Hz, 10A

(2) Ambient temperature: 2°C~40°C.

(3) Relative humidity: ≤80%.

(4) No vibration and airflow around.

(5) No electric dust, explosive and corrosive gases around.

3.2 Transport and storage conditions

(1) Storage temperature: -40°C~55°C.

(2) Relative humidity: ≤93%.

4. Installation

This section describes the instructions that you should abide when install the centrifuge to ensure your safety and the optimum performance. Before moving the centrifuge, the rotor must be removed.

WARNING

- Improper power supply may damage centrifuge.
- Make sure the power source conforms to the required power supply before connecting.

4.1 Location

(1) Place this centrifuge on a firm, flat and level surface, ensure the four feet of this centrifuge stand on the counter firmly.

Avoid installing on a slippery surface or surface prone to vibration.

(2) Ideal ambient temperature is 20°C ± 5°C, avoid placing the centrifuge in direct sunlight if temperature exceeds 30°C.

(3) Keep clear of the centrifuge at least 10cm on both sides and at least 30cm behind it to guarantee the cooling efficiency.

(4) Keep away from heat or water to avoid sample temperature issues or centrifuge failures.

4.2 Connection of the power cord and grounding

WARNING

- To avoid electrical shocks, ensure your hands are dry when touching the power cord.
- This centrifuge must be grounded properly.

A minimum 10A outlet providing a sufficient ground is required, and this must meet local safety requirements.

5. Structure

D3024

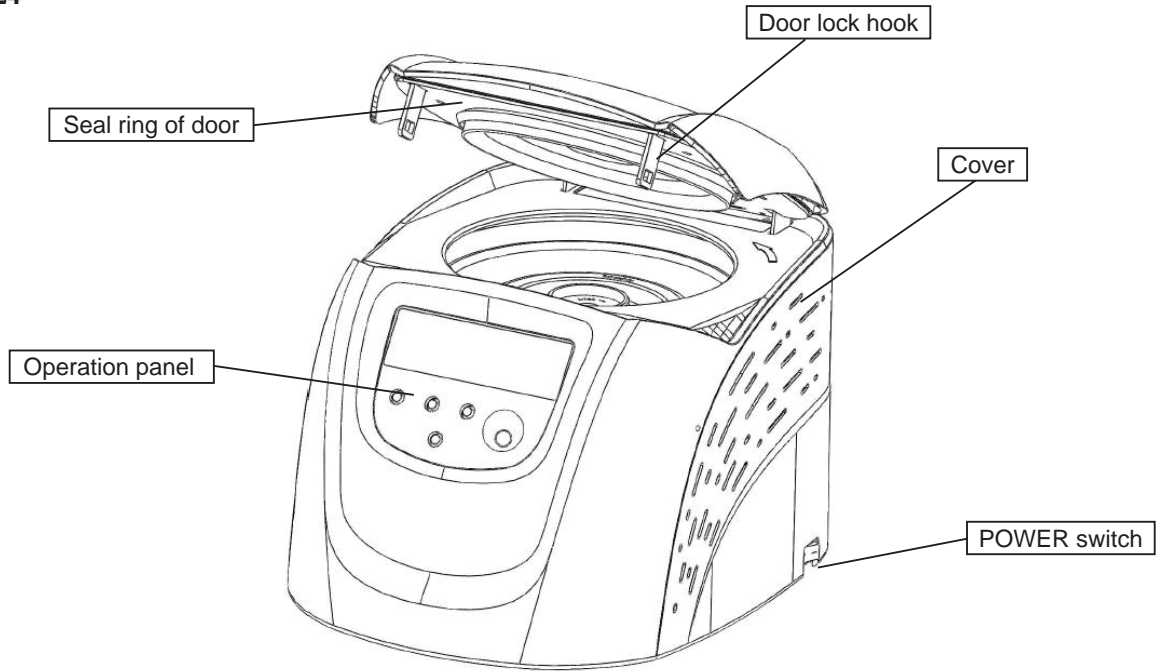

Figure 5.1 Front view of centrifuge D3024

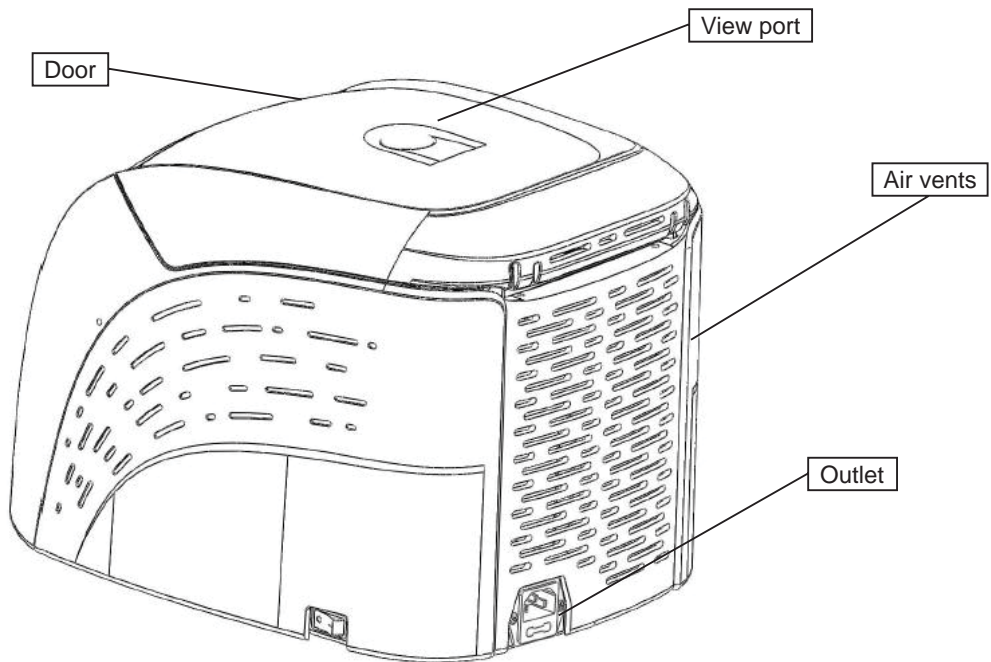

Figure 5.2 Rear view of centrifuge D3024

D3024R

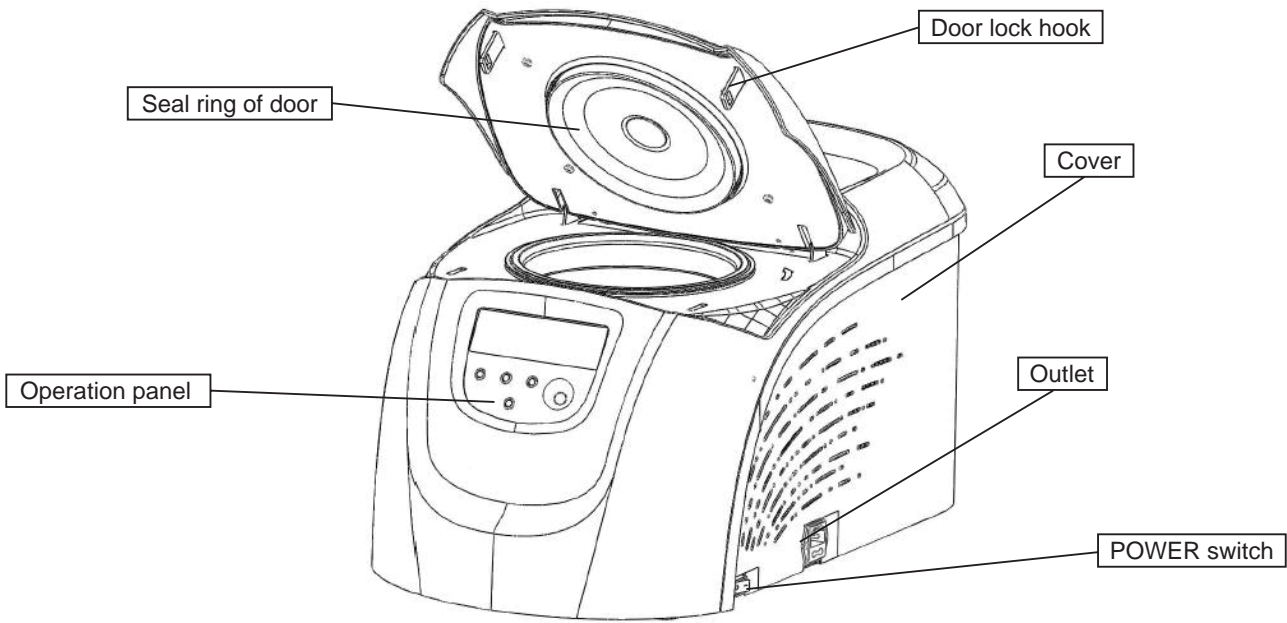

Figure 5.3 Front view of centrifuge D3024R

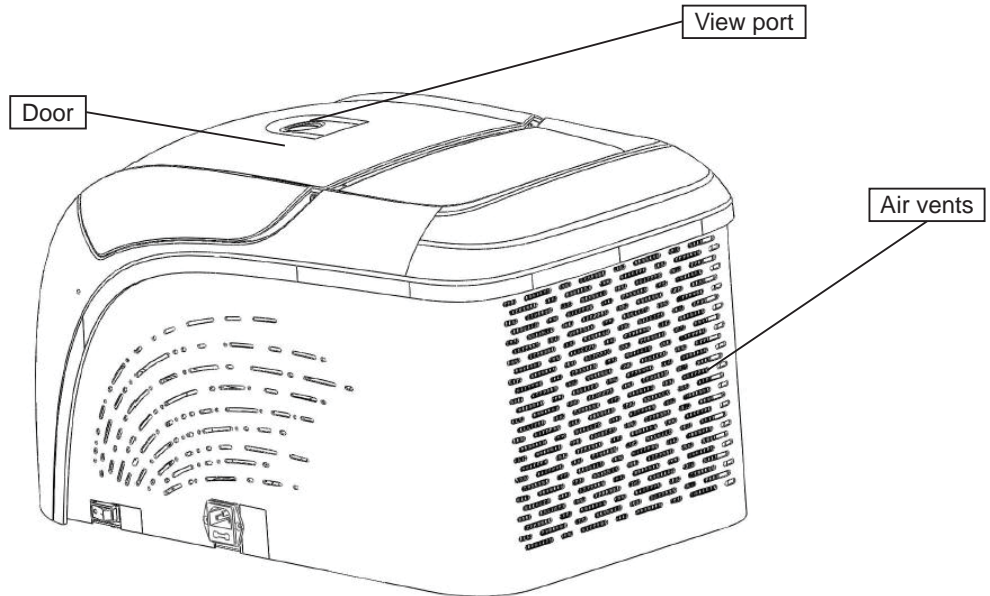

Figure 5.4 Rear view of centrifuge D3024R

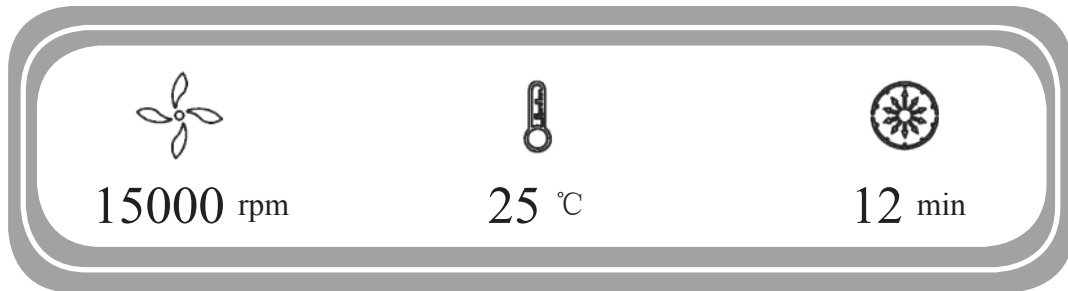



Figure 6-2 The main interface (D3024)

Main interface of D3024 model is as figure 6-2. The speed is set to be 15000rpm, temperature of centrifugal chamber is 25°C and the running time is 12 minutes. When speed symbol  is rotating, this indicates the centrifuge is running. If the rotation is faster, the speed is higher. Temperature of chamber is displayed and cannot be controlled. Time symbol  displays the ratio of working to time setting. The total time setting is divided into 10 sections.

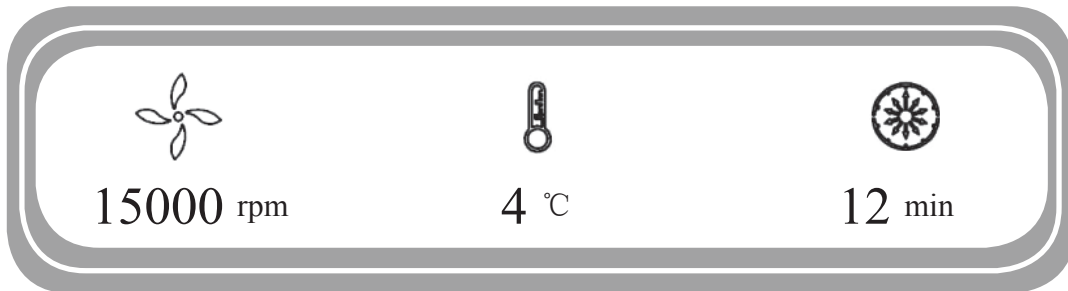





Figure 6-3 The main interface (D3024R)

Main interface of D3024R model is as figure 6-3. The speed is set to be 15000rpm, temperature of centrifugal chamber is 4°C, and the running time is 12 minutes. When speed symbol  is rotating, indicating the centrifuge is running. The rotation is faster, the speed is higher. When temperature symbol  is blinking, indicating refrigeration is running, no blinking means refrigeration stop working. Time symbol  displays the ratio of working to time setting. The total time setting is divided into 10 scales.

7. Rotor Preparation

7.1 Prepare the samples

7.2 Inject the samples into tubes

CAUTION

- Do not overload samples into the centrifuge which will cause leaking.
- Do not exceed the actual capacity allowed in the user manual.

7.3 Keep the tubes balanced

- Although the centrifuge can accept sample balancing by eye, we recommend that you keep this centrifuge in a well-balanced condition to extend its life expectancy.
- Never intentionally run the centrifuge under an unbalanced condition even though the allowable imbalance is not exceeded.

7.4 Inspect the rotor

Check the rotor for corrosion or scratches before using.

CAUTION

- If any abnormality such as corrosion or scratches are found, stop using the rotor and contact our service center.
- Only manufacturer's rotors must be used with the unit.

7.5 Symmetrically load centrifuge tubes to rotor

CAUTION

- Make sure the rotor lid is securely fixed on the rotor, as well as the rotor and shaft are tightened. Otherwise, the rotor may be moved off while rotating and cause damage to the centrifuge and rotor.
- Firmly tighten the rotor lid to the rotor.

8. Operation

CAUTION

- Do not push or lean against the centrifuge while it is running.
- Do not run the centrifuge when fragments or sample solutions are left in the centrifuge chamber. Always keep the centrifugal chamber clean.
- If the centrifuge makes strange noise during operation, stop it immediately and contact our service center. Notify them of the warning code if displayed.

8.1 Normal operation

Turn on the power switch, centrifuge will start self-diagnostic checks, see figure 8-1 below:

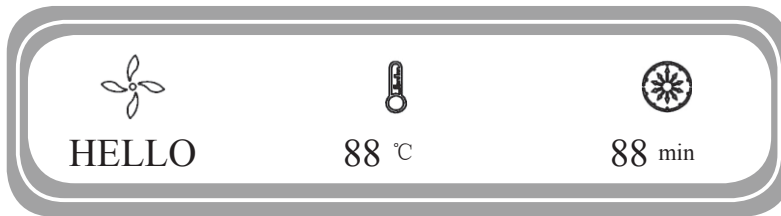

Figure 8-1 Self-checking interface

After self-diagnostics, the centrifuge will display the accumulative running time, see figure 8-2 below:

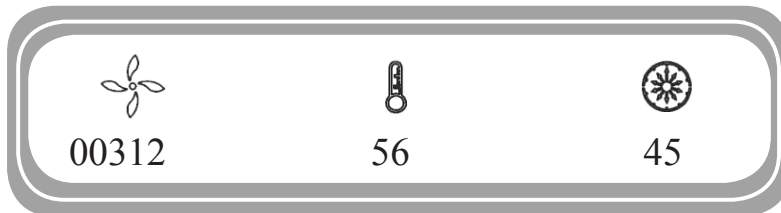

Figure 8-2 Accumulative running time interface

Figure 8-2 indicates the centrifuge has accumulated running time 312 hours 56 minutes and 45 seconds, and then the centrifuge displays the last running values, see figure 8-3 below:

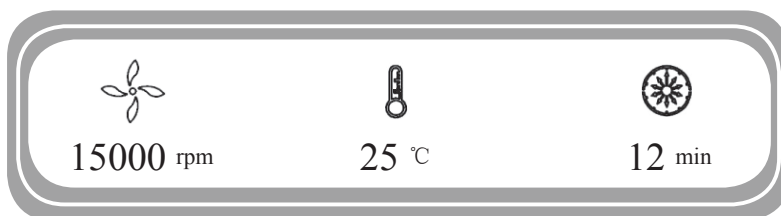

Figure 8-3 Last running interface

- Speed: 15000rpm; running time: 12minutes; centrifugal chamber temperature: 25°C
- Release the door.

8.1.1 Load and replace the rotor

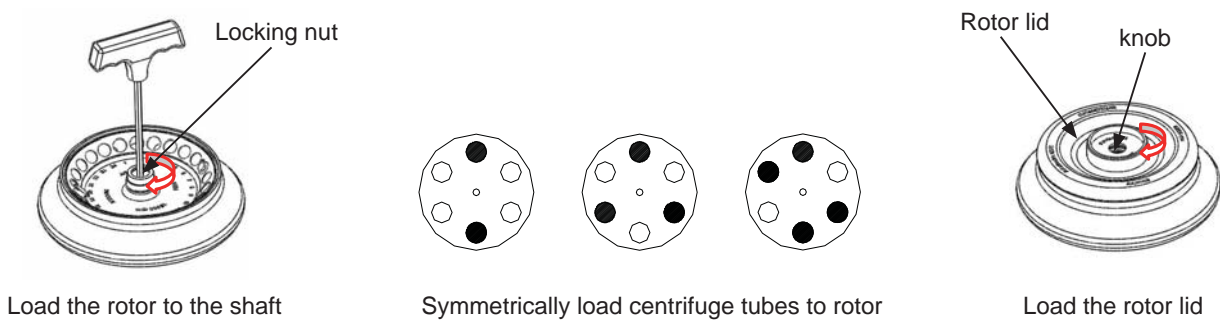





Figure 8-4 Load the rotor

CAUTION





- Attach the rotor to the rotor shaft. Ensure the rotor is in position and connected with the shaft, tightening the locking nut to secure the rotor with shaft, to prevent the rotor damaging the centrifuge.
- Ensure the rotor lid is firmly tightened to the rotor.

- Load the rotor to shaft to ensure rotor is in position until it connected with the shaft.
- You should feel a 'click' when the rotor is properly loaded to the shaft. If not, there may be something stuck between the rotor and the shaft. Double check and clean it if necessary.
- Rotate the rotor slightly with your fingers to check if the rotor vibrates. If so attach the rotor again.
- Rotate the nut clockwise using the wrench to tighten the rotor to the shaft firmly.
- Close the rotor lid, firmly tighten clockwise the lid to the rotor and ensure is in position. Close the door and then start running.
- The method of removing the rotor is as same as the above mentioned by turning the locking nut counterclockwise.



8.1.2 Set the operation programs

Press the **SELECT** button to select required program. The value can be modified when the program is flashing. Rotate the program button clockwise  to increase parameter value. Rotate the program button clockwise  to decrease parameter value. Rotate the program button  faster, and the parameter value will increase faster. The minimum speed increment is 100 rpm, the minimum time increment is 1 second.



(1) Set the speed

- Press the select button **SELECT** until the speed rpm is displayed.
- When the speed button is selected, the speed symbol will flash the speed value.
- The minimum speed value you can set 200rpm, the minimum increment is 10rpm.
- Rotate program button clockwise  to increase speed value. Rotate the program button anti-clockwise  to decrease speed value.
- You can speed-up set the speed value by rotating program button  quickly.
- There is a circulating function to increase/decrease the speed values. Rotate the program button clockwise  to change settings from small → large → maximum → minimum. Rotate the program button anti-clockwise  to change settings from large → small → minimum → maximum.

(2) Set the time

- Press button , time value flashes in the time setting mode.
- Rotate the program button  to set running time from 30 seconds to 99 minutes.
- When the time displays HD, this is a continuous running mode.

(3) Set the temperature (D3024R)



- Press select button , until the temperature set flashes for the temperature setting mode.
- Rotate the program button , and input temperature value range from -20°C to 40°C.
- When temperature symbol  flashes, this indicates the refrigeration system is running, not flashing indicates the refrigeration is not running.

8.1.3 Start the operation

(1) Press button  to start running

- The door must be locked before rotor starts spinning.
- Timer will operate once the speed setting value is reached, the screen displays the remaining run time.

(2) View and modify the operation programs

- Operation programs can be modified after the centrifuge reaches the set speed.
- Pressing button , returns the display to the program interface and displays setting programs. Press button  to the desired program. When flashing, rotate parameter button  to modify values. Release the button after 5 seconds, and the centrifuge will return to normal operation mode and run according to the new value.
- If the set time value has been modified, the operation time is not affected and will continue.

(3) Warning display

- If an error occurs during the operation, the centrifuge will brake to stop automatically, and display the error code on the time/display area. The error code can be checked in the table 10-1, and corrective actions can be applied accordingly.

8.1.4 End the operation

(1) The centrifuge will brake when it reaches the set time or  button is pressed.

- When the rotor stops rotating, the centrifuge will start beeping to alert the operation has finished.

(2) Open the door

- The door can be released automatically when the operation has stopped (D3024).
- With the door closed, you are able to press button  to open it.
- After ending the operation, the program will store the setting values of this operation, and will recall these values when restarting the program.



(3) Open the door and take out the rotor and samples.

8.2 RCF operation

- (1) Turn on the power switch
- (2) Set a RCF (Relative Centrifugal Force) value

CAUTION

- Do not exceed the allowable maximum RCF value of the rotor and adapters.

- Press the select button  and choose speed unit $\times g$, the speed symbol will flash into RCF value input status.
- If no button is pressed after the speed value has flashed after 5 seconds, the input mode will be shut down.
- Rotate program button  to input a RCF value, RCF increment is $10 \times g$.



- (3) Set operating conditions

The other operation, please refer to the section 8.1.

8.3 Pulse operation

This function is used to remove the residual samples adhered to the interior of the tubes or for quick spins.

Note: The button works only while the rotor stopped and the door is locked.

- (1) Turn on the power switch and load the rotor to the shaft, tighten the rotor lid and make sure it is in secured position, and then close the door.
- (2) The centrifuge goes into preparation mode and displays last running values. The values can be reset.
- (3) Press  knob and hold, the centrifuge will speed up to the setting speed. While releasing the  knob during acceleration, the centrifuge will start to decelerate and stop.

9. Maintenance

9.1 Cleaning

CAUTION

- If do not follow the recommended instructions for cleaning or disinfecting this may damage the centrifuge.

(1) Centrifuge

- If the centrifuge is exposed to ultraviolet rays for a long time, the color of the door may be changed or the label may be peel off. After using, cover the centrifuge with a piece of cloth to protect it from direct exposure.
- If the centrifuge needs cleaning, clean it with a cloth or sponge moistened with a neutral detergent solution.
- Sterilize the centrifuge by wiping with a cloth moistened with 70% ethanol solution.

(2) Rotor chamber

CAUTION

- Do not directly pour water, neutral detergent or disinfectant solution into the rotor chamber, otherwise fluids may leak into the drive units and cause corrosion or deterioration to the bearings.

- If the rotor needs cleaning, clean with cloth or sponge moistened with a neutral detergent solution. Sterilize the centrifuge by wiping with a cloth moistened with 70% ethanol solution.

(3) Drive shaft

- We recommend regular maintenance for drive shaft. You can wipe the drive shaft with soft cloth, and then apply a thin coat of silicon grease.

(4) Door

- Clean and sterilize the door using the same method as the section(1)above.

(5) Rotor

- To prevent corrosion, remove the rotor from rotor chamber. If not in use for a long term, then detach the rotor lid and turn upside down to dry the tube holes and keep clean.
- For sample leaks in the rotor, rinse the rotor with water. Apply a thin coat of silicon grease to the rotor when it is completely dry.
- The rotor should be checked every 3 months to ensure the tube and rotor holes keep are clean and apply a thin coat of silicon grease.

(6) Drain (D3024R)

- The centrifuge is equipped with a drain pipe for excess water. Drain off excess water in drain pipe.

9.2 Consumables

Replaceable wearing parts listed below. It is recommended to replace these according this table.

Item	Replacement parts	Replacement conditions
1	Seal ring of door	Cracked
2	Rubber housing of temperature sensor	
3	Seal rings of centrifuge chamber (D3024R)	

9.3 The replacement of seal rings

9.3.1 Instructions

There are three high-temperature rubber seal rings that are fitted to the rotor to achieve a bio-safe condition. The seal rings may come loose or age after numerous autoclaving and need to be replaced or re-installed.

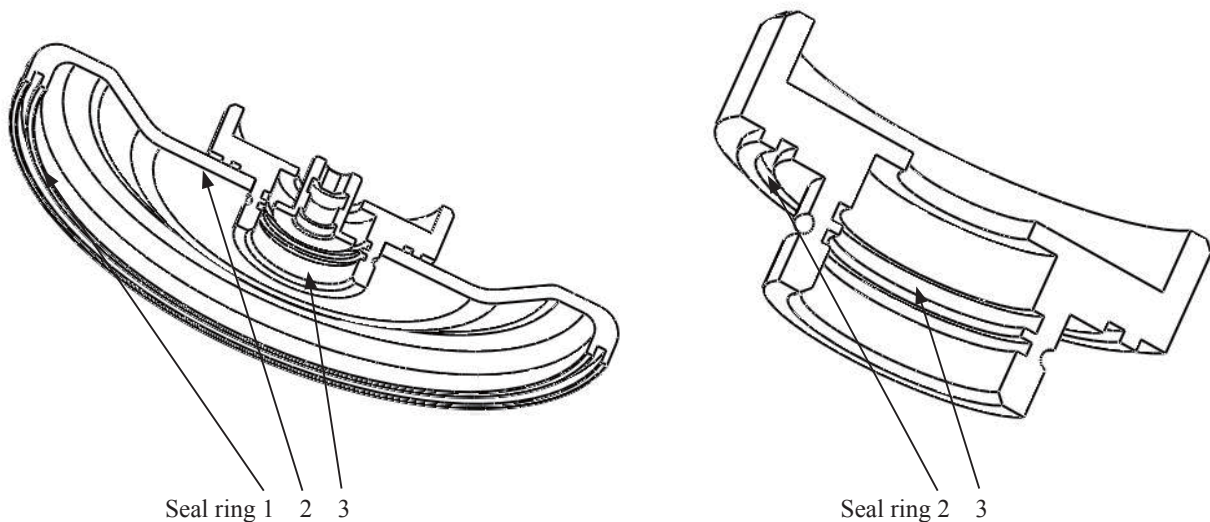

Figure 9-1 Seal rings of rotor

9.3.2 Replacement methods

- (1) Clean the seal ring slot with neutral detergent solution and ensure its dry.
- (2) Evenly coat with glue (501) in the seal ring slot and place seal ring into slot, press evenly to make it evenly contact to the slot bottom and bond firmly.
- (3) Leave for 20 minutes for the glue to completely solidify and set.

9.4 Routine inspection

- (1) Check the centrifuge is on a firm, flat and level surface, ensure four feet are seated on the surface firmly.
- (2) Check the centrifuge is grounded properly. Use a multi-meter to check if there is a short circuit between the power cord grounding pin and the motor shaft. If an open circuit is found, check for reasons and troubleshooting before use.

10. Troubleshooting

10.1 Possible problems and solutions

This centrifuge has a self-diagnostic function. If a problem occurs, an error/warning code will be displayed on the time display screen, and the operator can determine the malfunction with the warning code below.

Symptom		Causes	Solutions
Nothing appears on the screen when the power is turned on.		Facility power circuit breaker tripped. The fuse has blown.	Correct and turn on the power. Replace the fuse.
Error code appeared on the time display screen	E-02 Door fault	<ul style="list-style-type: none"> The door opened while running. Press the button  with the door opened. 	<ul style="list-style-type: none"> Close the door immediately. Close the door, and then start to operate.
	E-04 Temperature fault	<ul style="list-style-type: none"> The air vents are blocked. Radiator fan is damaged. 	<ul style="list-style-type: none"> Clean air vents. Replace radiator fan.
	E-06 Set wrong value	<ul style="list-style-type: none"> The setting value exceeds the allowable range. 	<ul style="list-style-type: none"> Modify the set value.
	E-10~86	Read the service manual.	Contact the service center.

Table 10-1 Possible problems and solutions

- Warning codes E-1~E-9 are related to incorrect operation/programming. You can continue running the centrifuge after implementing corrective procedures.

10.2 How to open the door

10.2.1 In the case of power on

CAUTION

- The door just can be opened while the power is on and rotor stops rotating.

- Turn on the power switch, release the door automatically.
- The door will be released automatically once the operation is finished.
- It is available to release the door by pressing button  once the rotor stops

10.2.2 In the case of power outage

The door cannot be opened automatically if there is a power outage. It is available to be opened manually as follows.

- Ensure if the rotor has stopped rotating.
 - Listen carefully to ensure no rotating sound can be heard.
- Insert a screw driver into a hole to open door.
 - Holes are located on the left and right sides of the unit.
 - Insert a screw driver into the two holes and push forward to release the door.

10.3 Replacement of fuses

(1) There are two fuses of D3024, 250V, 5A time-delay type, size: $\Phi 5 \times 20$. There are two fuses of D3024R, 250V, 10A time-delay type, size: $\Phi 5 \times 20$.

(2) The fuse holder is located in the power inlet. Pull out the fuse holder from power inlet and replace the fuses if necessary.

11. Instructions for the Rotor and Tubes

! CAUTION

- Read the instructions thoroughly, to properly load and use rotor.
- Do not exceed the allowable maximum speed of rotor, tube and adapters etc. Ensure the allowable maximum speed of adapters is lower than the rotor's maximum speed.

11.1 Rotor instructions

11.1.1 Rotor structure

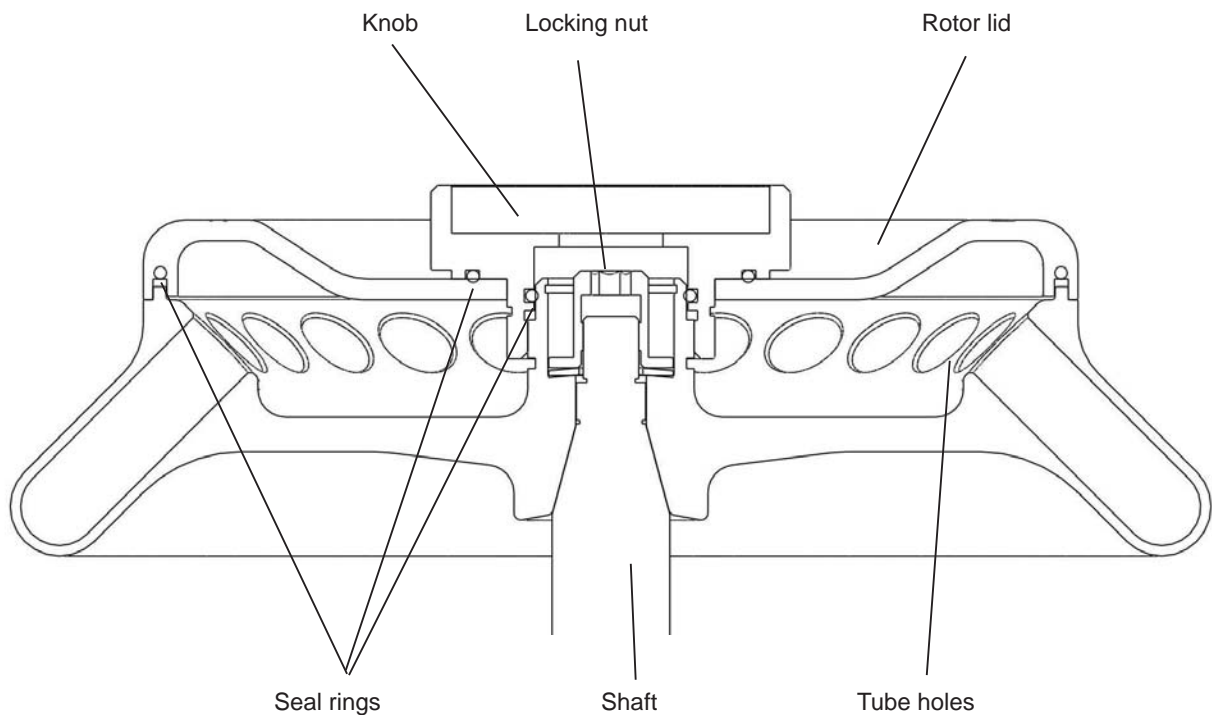

Figure 11-1 The rotor structure

11.1.2 Available rotors and adapters

All rotors are bio-safe when the rotor lid is tightened to the rotor and if centrifuge tubes are enclosed into rotor to ensure the sample does not leak in centrifugal process. If a rotor lid is not available, the rotor is not in a bio-safe condition. The rotors can be used as follows:

Rotor type	ID code	Tubes	Adapters	Maximum speed (rpm)	Maximum centrifugal radius rmax (cm)	Maximum RCF Rcf (×g)
1	AS24-2	2/1.5ml tube		15000	8.5	21380
		0.2ml PCR tube	A02P2	15000	6.9	17350
		0.5ml micro tube	A05P2	15000	7.6	19100
2	AS36-05	0.5ml micro tube		15000	8.5	21380
		PCR8 serial tube	A02P05	15000	7.6	19100
3	AS4-PCR8	PCR8 serial tube			6.5/7.2	16350/18100

Table 11.1 Rotors and adapters

11.1.3 Notice

- (1) The centrifuge rotor can separate samples with a density lower than 2.0 g/ml. If the samples density is over 2.0 g/ml, please calculate allowable speed depending on the following formula.

$$\text{Allow Speed (rpm)} = \text{Maximum speed} \times (2.0(\text{g/ml}) / \text{Sample density (g/ml)})^{1/2}$$
- (2) To prevent corrosion, remove the rotor from rotor chamber if not in use for a long term, then detach the rotor lid and place upside down to dry the tube holes.
- (3) If samples have leaked in the rotor holes, wash the hole with water, apply a thin coat of silicon grease on the rotor surface after drying.
- (4) It is necessary for a regular rotor maintenance and should be cleaned every 3 months to keep the tube holes and shaft clean. Apply a thin coat of silicon grease.

11.1.4 Autoclaving

The rotor is manufactured in high-strength aluminum alloy material and can be autoclaved: 121°C (1.0kg/cm²) 20 minutes.

11.1.5 Bio-safe seal ring

The rotor is sealed with three bio-safe high-temperature sealing rings. The seal rings wear or age after numerous autoclaving and may need to be replaced or re-installed. For replacement methods please refer to the section 9.3.

11.2 Tubes

11.2.1 Cleaning and sterilizing tubes

Conditions		Materials	PA	PC	PP
Cleaning	Cleaning fluids	Acidic(pH5 or lower)	X	X	X
		Acidic(higher than pH5)	O	O	O
		Alkaline(higher than pH9)	O	X	O
		Alkaline(pH9 or lower)	O	O	O
		Neutral(pH7)	O	O	O
		Warm water(up to 70°C)	O	O	O
	Ultrasonic cleaning	Neutral detergent(pH7)	O	O	O
Sterilization	Autoclaving	115°C(0.7kg/cm ²)30minutes	O	O	O
		121°C(1.0kg/cm ²)20 minutes	X	O	O
		126°C(1.4kg/cm ²)15 minutes	X	X	X
	Boiling	15 to 30 minutes	O	O	O
	Ultraviolet sterilization	200-300nm	X	X	X
	Gas sterilization	Ethylene oxide	O	X	O
		Formaldehyde	O	O	O

PA: Polyallomer PC: Polycarbonate PP: Polypropylene

11.2.2 Cleaning PC tubes

PC material is low in chemical resistance against alkaline solutions. Avoid using neutral detergents with pH higher than 9. Note that pH of some neutral detergents are still higher than 9 even if diluted according to the manufacturer' s instructions. Use detergent with its pH between 7 and 9.

11.2.3 Autoclaving PA、PC and PP tubes

PA begins softening at about 120°C, PC and PP at about 130°C. Autoclave PA tubes at 115°C (0.7kg/cm²) for 30 minutes, PC and PP tubes at 121°C (0.1kg/cm²) for 20 minutes. If a certain temperature is exceeded, the tubes may be deformed.

When use a sterilizing chamber, please operate as follows:

- (1) Place tubes in vertical position, mouths upward. If tubes are placed sideways, they may deform into an oval shape due to gravity.
- (2) Remove locking nut and lid to prevent from deformation or rupture.
- (3) Wait until the sterilizing chamber cools down to the room temperature before removing tubes.

11.2.4 Conditions and life expectancy of tubes

The life expectancy of plastic tubes depends on the characteristics of samples, speed of the rotor used, temperature applied and so on. When the plastic tubes are used for ordinary aqueous samples (pH between 5.0 and 9.0), their life expectancies are defined as follows.

Be operated at the maximum speed:

High quality tubes (PA、PC、PP): 30-50 operations

Ordinary tubes(PA、PC、PP): around 10 operations (Using in low speed can extend the tube life) .

Life expectancy of tubes also depends on the pretreatment conditions such as cleaning and sterilization, lifetime can be cut down.

Notice: Do not use damaged or cracked tubes.

12. Calculate RCF

Relative Centrifuge Force (RCF) can be determined with the following calculation formula.

$$RCF = 1.118 \times r \times n^2 \times 10^{-5}$$

R — rotating radius unit: cm; n — rotating speed, unit: rpm

13. Ordering information

Cat. No.	Model	Descriptions
912015139999	D3024	High Speed Micro-Centrifuge, with AS24-2 rotor kits, US plug, 110V/50Hz/60Hz
912115129999	D3024	High Speed Micro-Centrifuge, with AS24-2 rotor kits, Cn plug, 220V/50Hz/60Hz
912215129999	D3024	High Speed Micro-Centrifuge, with AS24-2 rotor kits, Euro plug, 220V/50Hz/60Hz
912315129999	D3024	High Speed Micro-Centrifuge, with AS24-2 rotor kits, UK plug, 220V/50Hz/60Hz
922015139999	D3024R	High Speed Refrigerated Micro-Centrifuge, with AS24-2 rotor kits, US plug, 110V/50Hz/60Hz
922115129999	D3024R	High Speed Refrigerated Micro-Centrifuge, with AS24-2 rotor kits, Cn plug, 220V/50Hz/60Hz
922215129999	D3024R	High Speed Refrigerated Micro-Centrifuge, with AS24-2 rotor kits, Euro plug, 220V/50Hz/60Hz
922315129999	D3024R	High Speed Refrigerated Micro-Centrifuge, with AS24-2 rotor kits, UK plug, 220V/50Hz/60Hz
Accessories		
19400006	AS24-2	Rotor kits with cover, fixing clips and O' ring, 15000rpm, 2ml*24, used with D3024 & D3024R
19400007	AS36-05	Rotor kits with cover, fixing clips and O' ring, 15000rpm, 0.5ml*36, used with D3024 & D3024R
19400008	AS4-PCR8	Rotor kits with cover, fixing clips and O' ring, 15000rpm, 4-PCR8, used with D3024 & D3024R
19500001	A02P2	0.2ml rotor adapter, used with A12-2 & AS24-2 rotors, 24pcs/pk
19500002	A05P2	0.5ml rotor adapter, used with A12-2 & AS24-2 rotors, 24pcs/pk
19500003	A02P05	0.2ml rotor adapter, used with AS36-05 rotor, 36pcs/pk

14. Warranty

14.1 Warranty of centrifuge

This centrifuge is guaranteed for two years from the date of delivery provided that it has been operated and maintained properly.

14.2 Warranty of the rotor

The rotor is guaranteed for 5 years from the date of delivery upon manufacturer. Please pay attention, do not use the rotor once it has been corrosion or fatigue damage. The warranties of the centrifuge and the rotor become invalid in the case of the following conditions even if within the guarantee period expires:

- (1) Failures caused by incorrect installation.
- (2) Failures caused by rough or improper handling.
- (3) Failures caused by conveyance or relocation after installation.
- (4) Failures caused by unauthorized disassembly or modification.
- (5) Failures caused by using non-standard spare parts or accessories and unauthorized modification of the rotor or centrifuge.
- (6) Failures caused by natural disasters including fire, earthquakes and so on.
- (7) Consumables and parts have a limited guarantee period.

15. After-sales Service

In order to ensure to operate centrifuge safely and efficiently, it is necessary for regular maintenance. If centrifuge has problems, do not attempt to repair it by yourself. Contact our sales or service center.

SCIOGEX, LLC

1275 Cromwell Ave.

Suite C6

Rocky Hill, CT 06067

USA

Tel: 1- (860) 436-9221

Fax: 1- (860) 436-9745

info@scilogex.com

www.scilogex.com